

*Pocos elementos para grandes resultados*

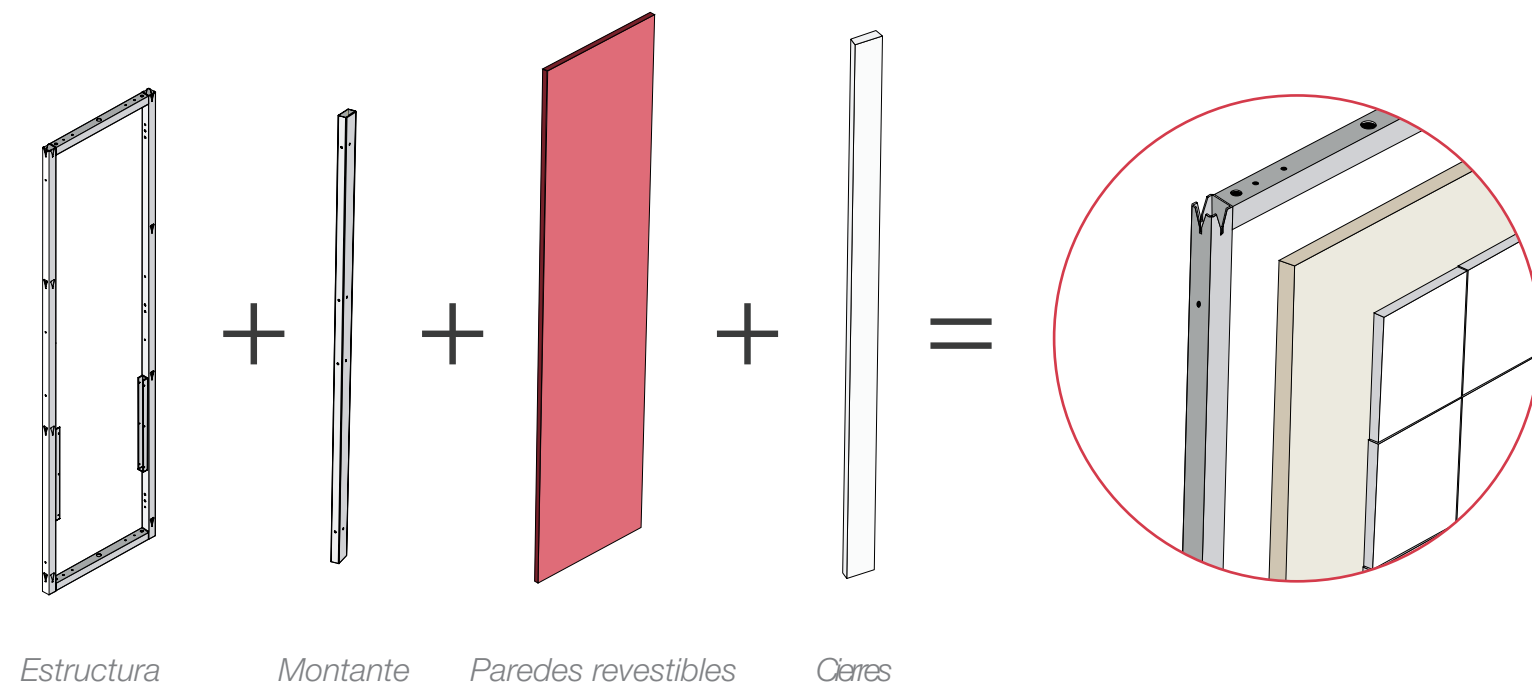

*Modificable en cualquier momento*

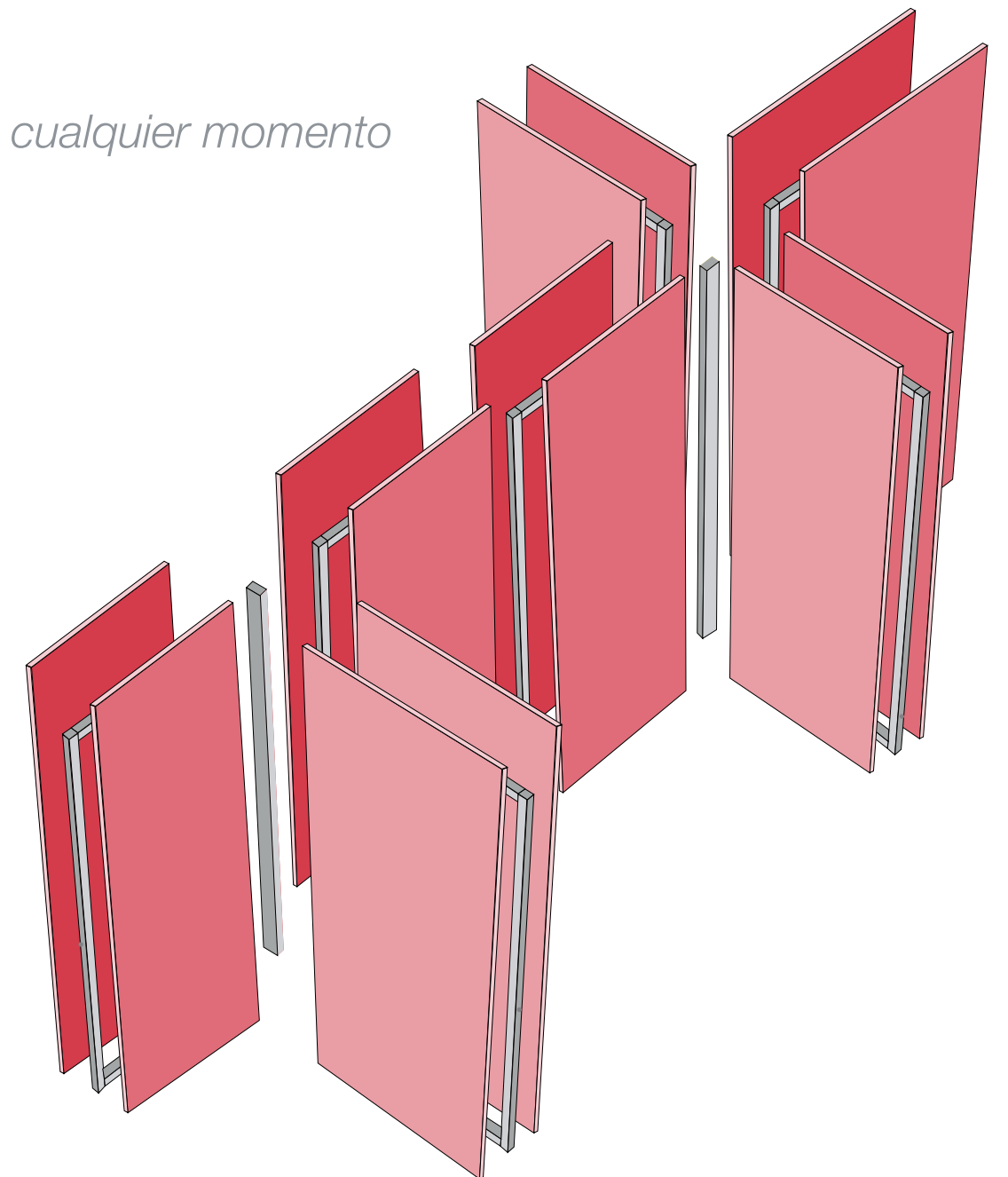

*Fácil, limpio, económico, duradero*

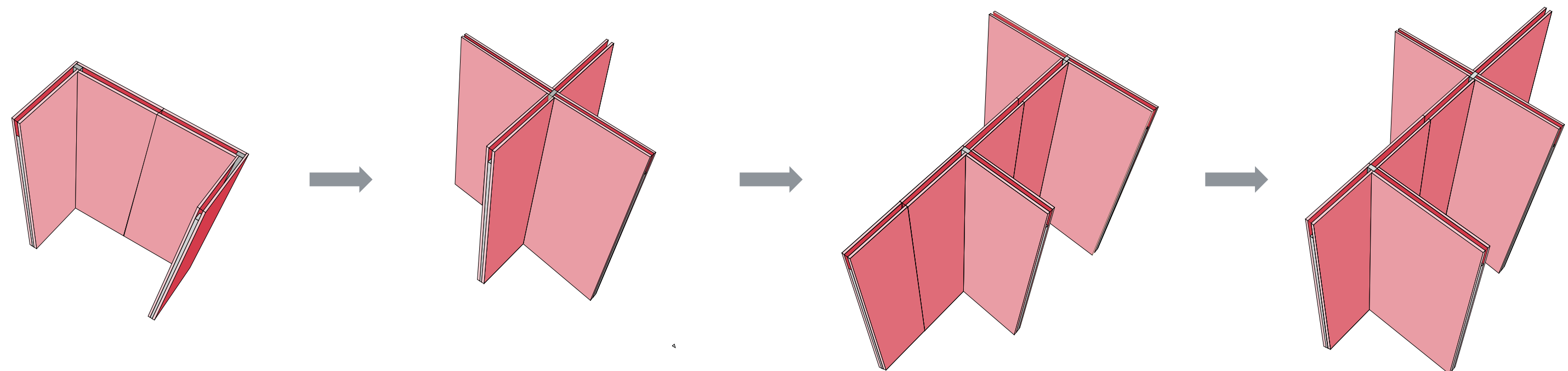

Composición en "L"

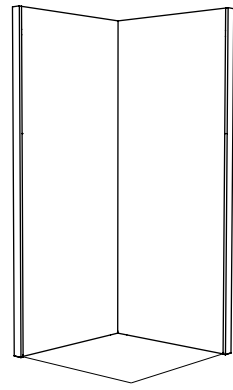
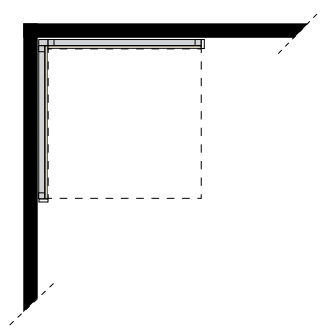

Composición en "X"

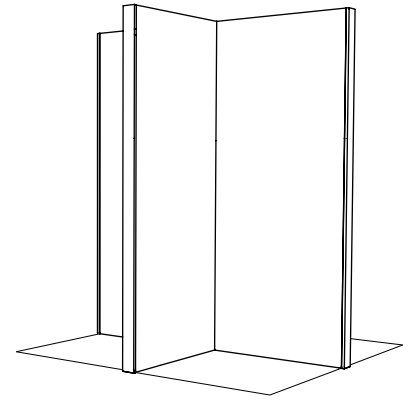
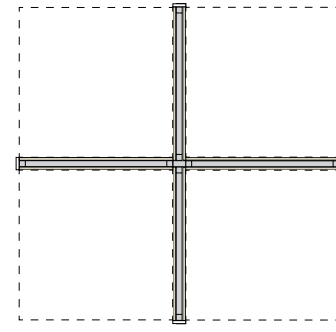

Composición en "T"

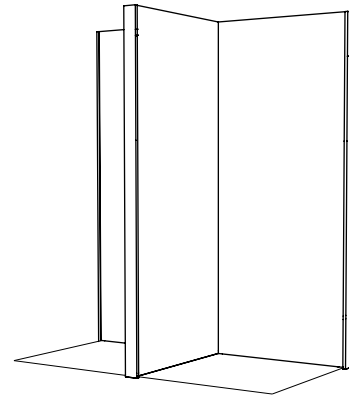
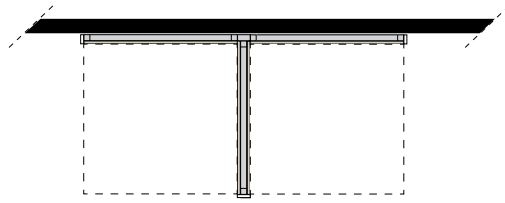

Composición en "H"

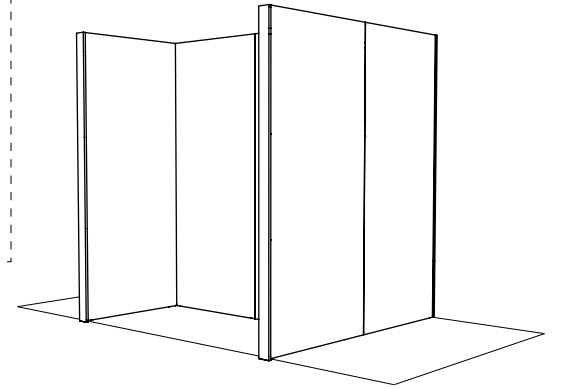
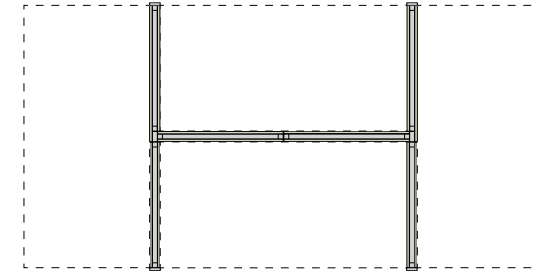

Composición en "Z"

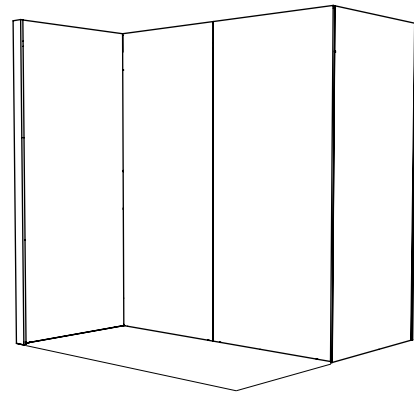
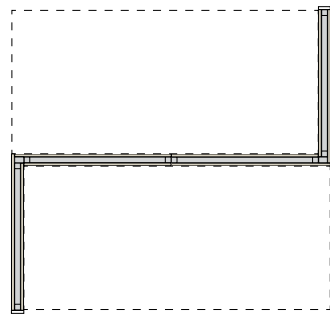

Composición en "Y"

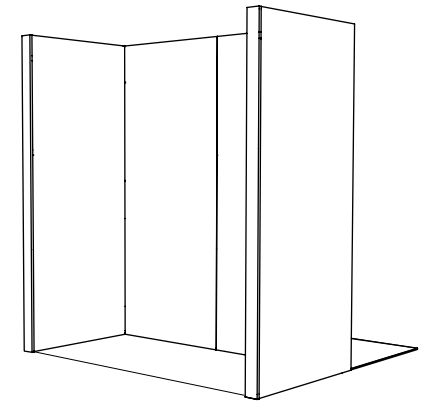
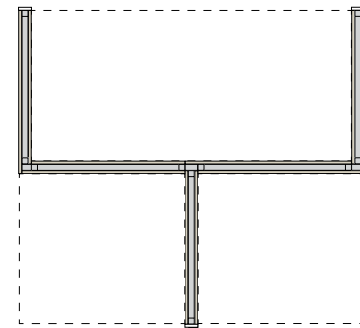

Composición en doble T

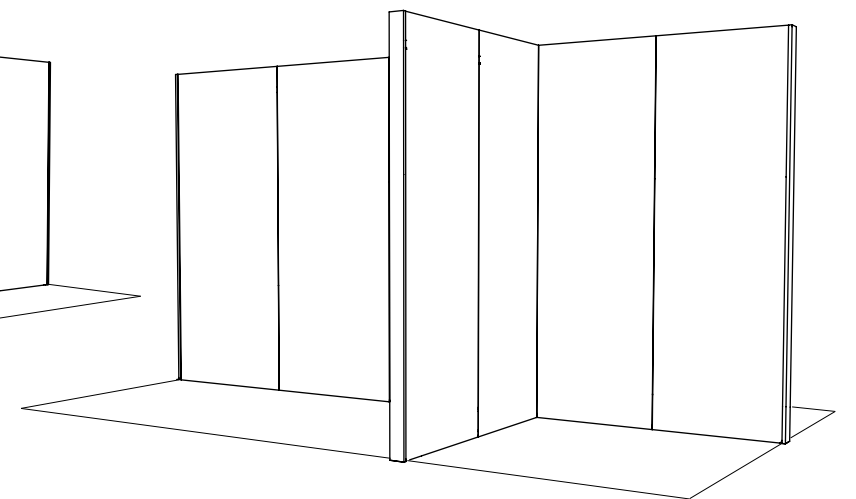
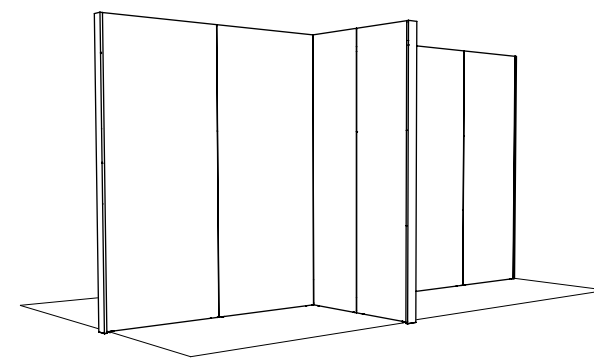
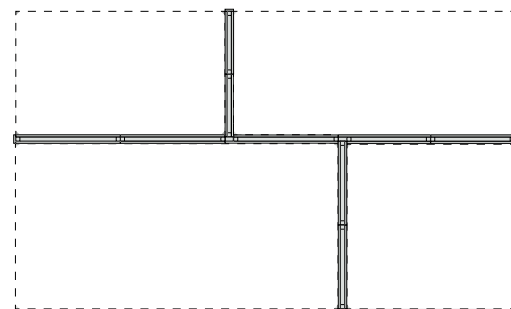

Composición en TY Y PANELES WALLTECH

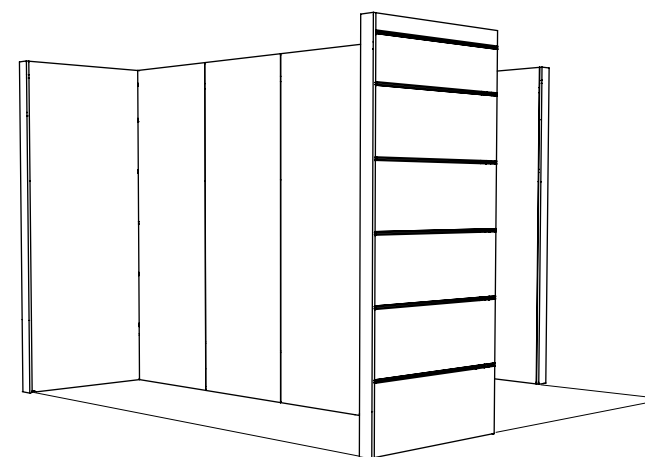
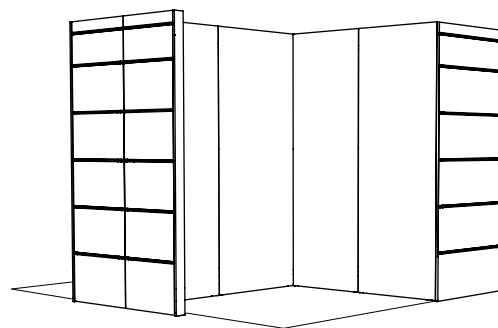
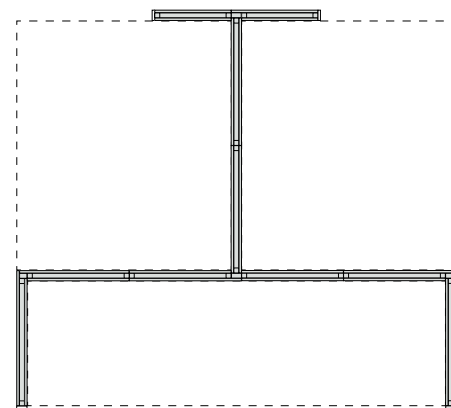

Composición doble L a muro con expositor metálico

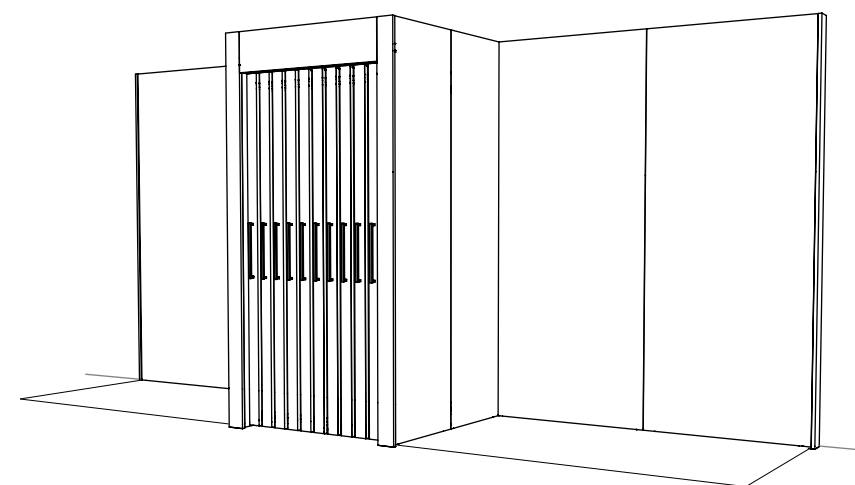
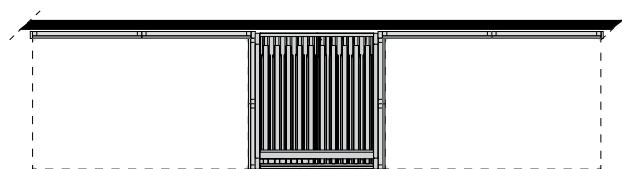

Composición isla doble T con expositores metálicos

